

Aug.1.2018 Copyright 2018 HIROSE ELECTRIC CO., LTD. All Rights Reserved.
 In case that the application demands a high level of reliability, such as automotive,
 please contact a company representative for further information.

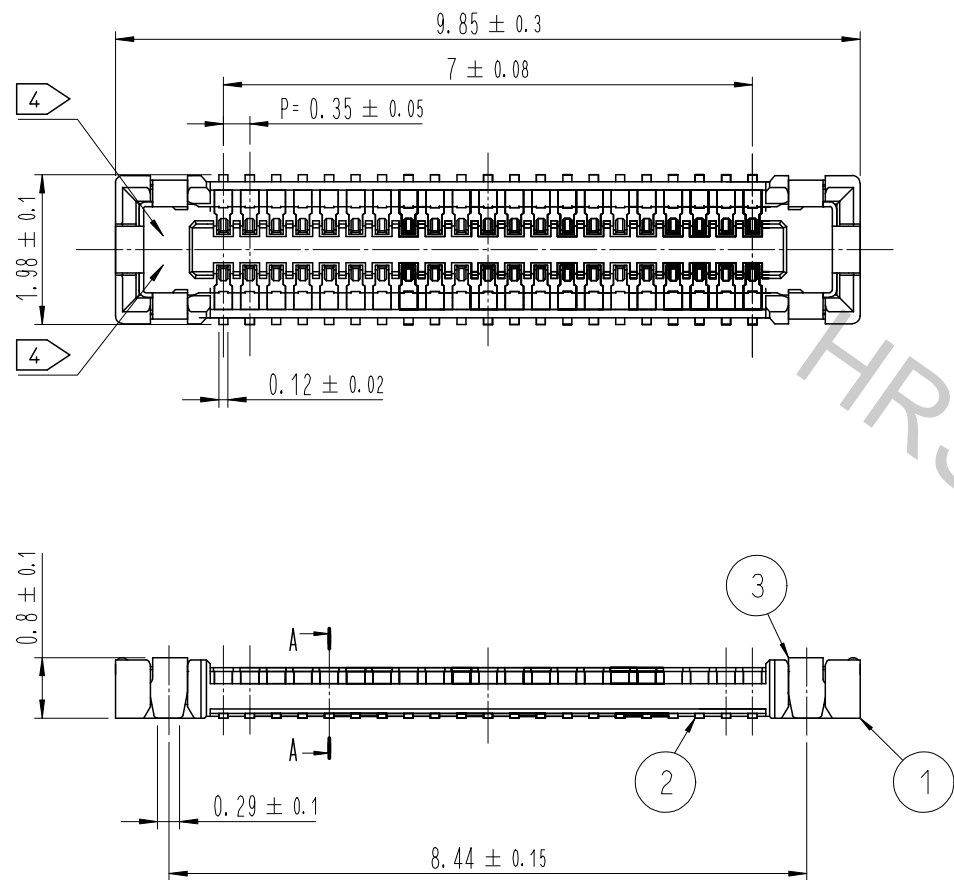

△數 COUNT	訂正事項 DESCRIPTION OF REVISIONS	擔當 B Y	檢圖 CHKD	年月日 DATE	△數 COUNT	訂正事項 DESCRIPTION OF REVISIONS	擔當 B Y	檢圖 CHKD	年月日 DATE
△					△				
△					△				
△					△				

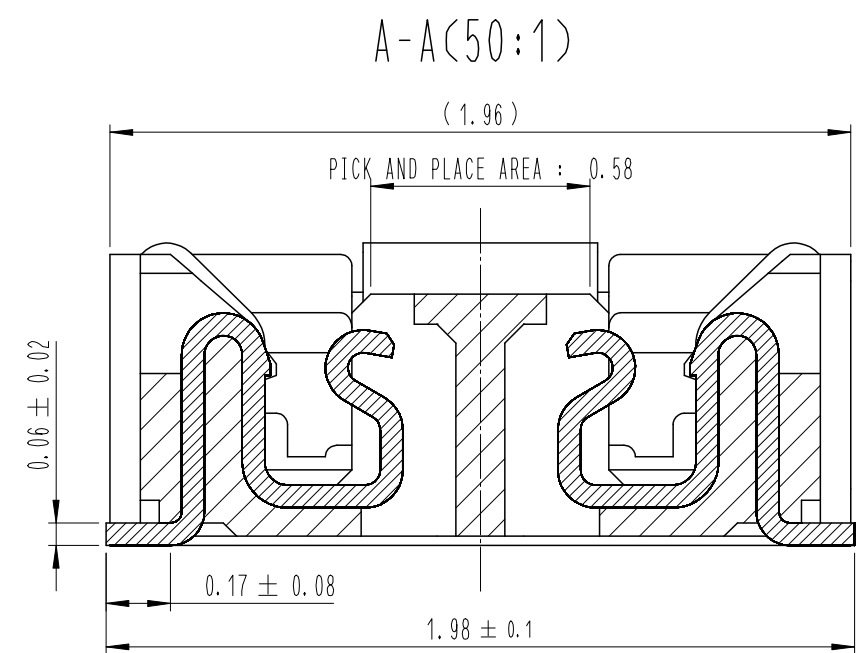

ENGAGEMENT FIGURE (50:1)

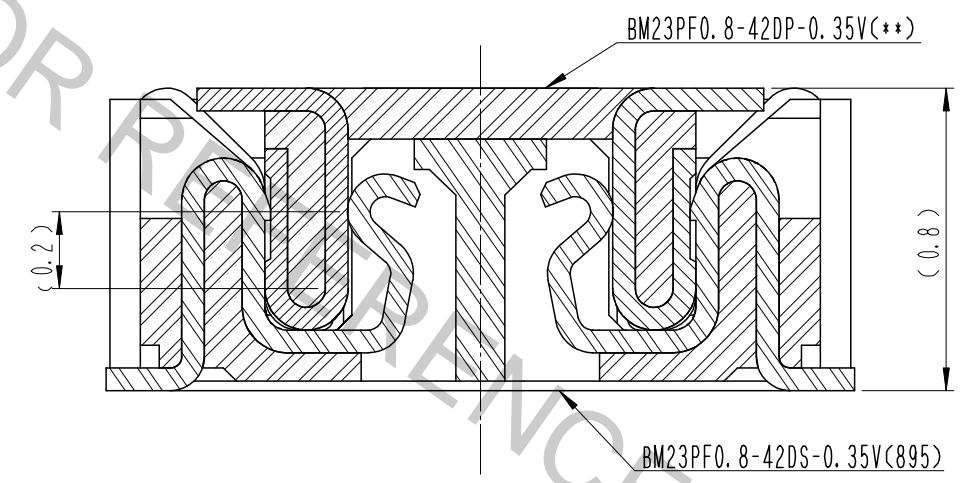

DRAWING FOR REFERENCE
 This is subject to change without notice

- NOTE
- 1. ALL LEAD CO-PLANARITY SHALL BE 0.08mm MAX.
 - 2. CONTACT PLATING SPECIFICATIONS.
 CONTACT AREA : GOLD 0.05 μm MIN.
 SMT LEAD : GOLD 0.05 μm MIN.
 UNDERPLATING : NICKEL 1 μm MIN.
 (SURFACE : SEALING)
 - 3. METAL FITTING PLATING SPECIFICATIONS.
 SMT LEAD : GOLD 0.05 μm MIN.
 UNDERPLATING : NICKEL 1 μm MIN.
 (SURFACE : SEALING)
 - 4. HRS MARK AND CAV NO. IS INDICATED IN APPROX POSITION SHOWN.

4	PS	CLEAR (EMBOSSED CARRIER TAPE)								
3	COPPER ALLOY	3								
2	COPPER ALLOY	2	6	PS	BLACK (PLASTIC REEL)					
1	LCP	UL94 V-0, BLACK	5	POLYESTER	CLEAR (COVER TAPE)					
NO.	MATERIAL	FINISH, REMARKS	NO.	MATERIAL	FINISH, REMARKS					
REMARKS						DRAWN	DESIGNED	CHECKED	APPROVED	RELEASED
						S. H. JUNG	S. H. JUNG	H. W. JO	T. S. KANG	17.05.09
						17.05.09	17.05.09	17.05.09	17.05.09	17.05.09
CODE NO. (OLD)	DRAWING NO. EDC3-632163		PART NO. BM23PF0.8-42DS-0.35V(895)							
SCALE 10:1	HRS HIROSE KOREA CO., LTD.		CODE NO. CL 6644-0081-6-895							
UNITS mm						1/3				

1 2 3 4 5 6 7 8

6 RECOMMENDED PCB LAYOUT

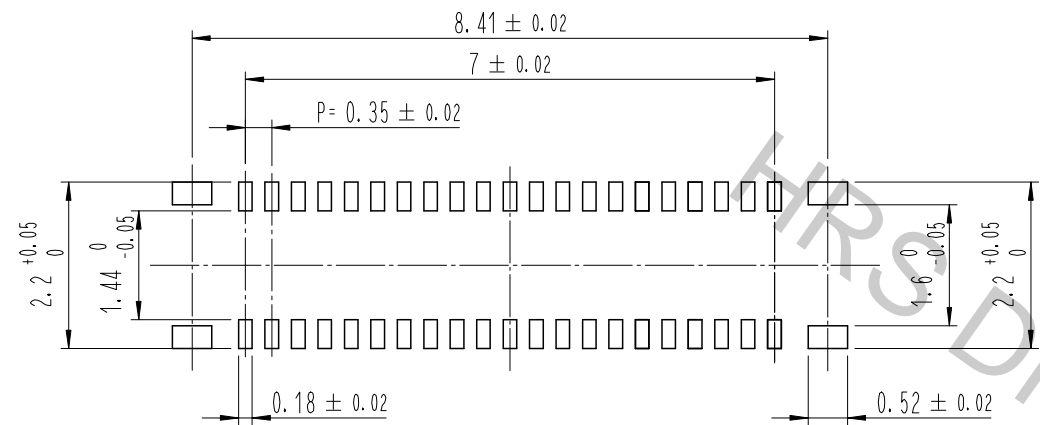

RECOMMENDED METAL MASK DIMENSIONS
 METAL MASK THICKNESS : 100 μm

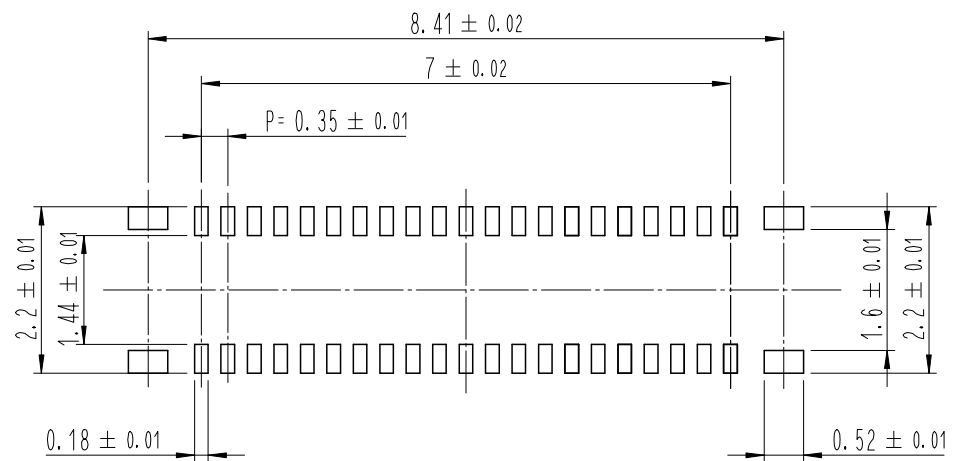

5 RECOMMENDED REFLOW TEMPERATURE PROFILE USING LEAD-FREE SOLDER PASTE.

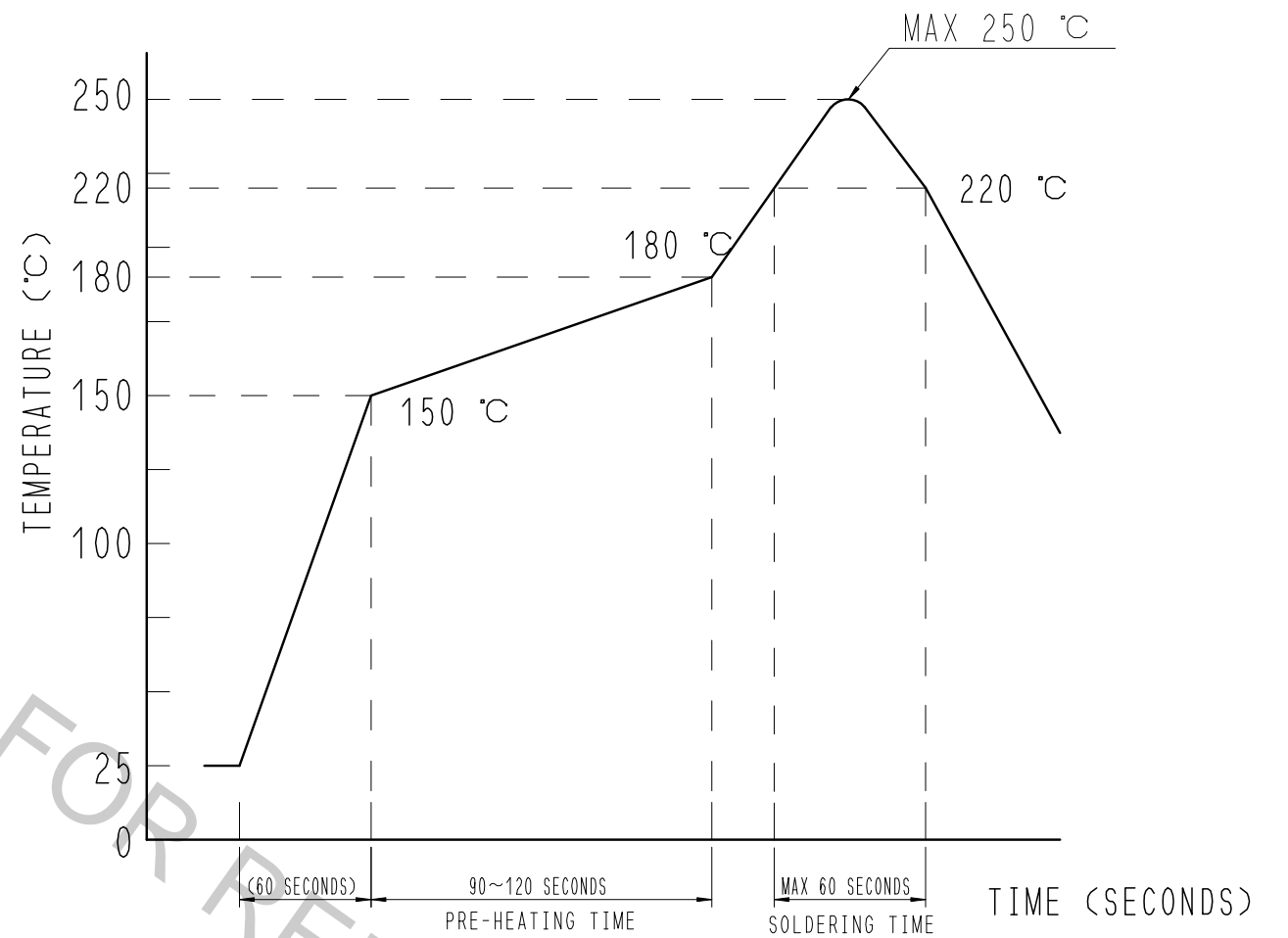

REFLOW METHOD: N2 REFLOW
 NUMBER OF REFLOW CYCLES: 2 CYCLES MAX.
 1) REFLOW TIME
 DURATION ABOVE 220°C: 60 SEC MAX.
 (PEAK TEMPERATURE: 250°C MAX)
 2) PRE-HEAT TIME
 PRE-HEAT TEMPERATURE(MIN): 150°C
 PRE-HEAT TEMPERATURE(MAX): 180°C
 PRE-HEAT TIME: 90-120 SEC.

- 5 THIS TEMPERATURE PROFILE IS PER THE CONDITIONS SHOWN ABOVE. ADDITIONAL FACTORS, SUCH AS SOLDER PASTE TYPE, PCB SIZE AND OTHER MOUNTED COMPONENTS COULD AFFECT THE PROFILE, THEREFORE, A THOROUGH EVALUATION OF MOUNTING CONDITION IS REQUIRED PRIOR TO PRODUCTION. TEMPERATURE IS MEASURED AT CONTACT LEAD.
- 6 PLEASE CONTACT US IN CASE YOU WILL MAKE DIFFERENT SETTINGS FROM OUR RECOMMENDATION.

1 2 3 4 5 6 7 8

 SCALE 10:1 UNITS mm	DRAWING NO.	EDC3-632163	PART NO.	BM23PF0.8-42DS-0.35V(895)
	HIROSE KOREA CO., LTD.		CODE NO.	CL 6644-0081-6-895
				2/3

Aug.1.2018 Copyright 2018 HIROSE ELECTRIC CO., LTD. All Rights Reserved.
 In case that the application demands a high level of reliability, such as automotive,
 please contact a company representative for further information.

EMBOSED CARRIER TAPE PACKAGING (5:1)

C-C (5:1)

STYLE AND DIMENTION OF REEL (FREE)

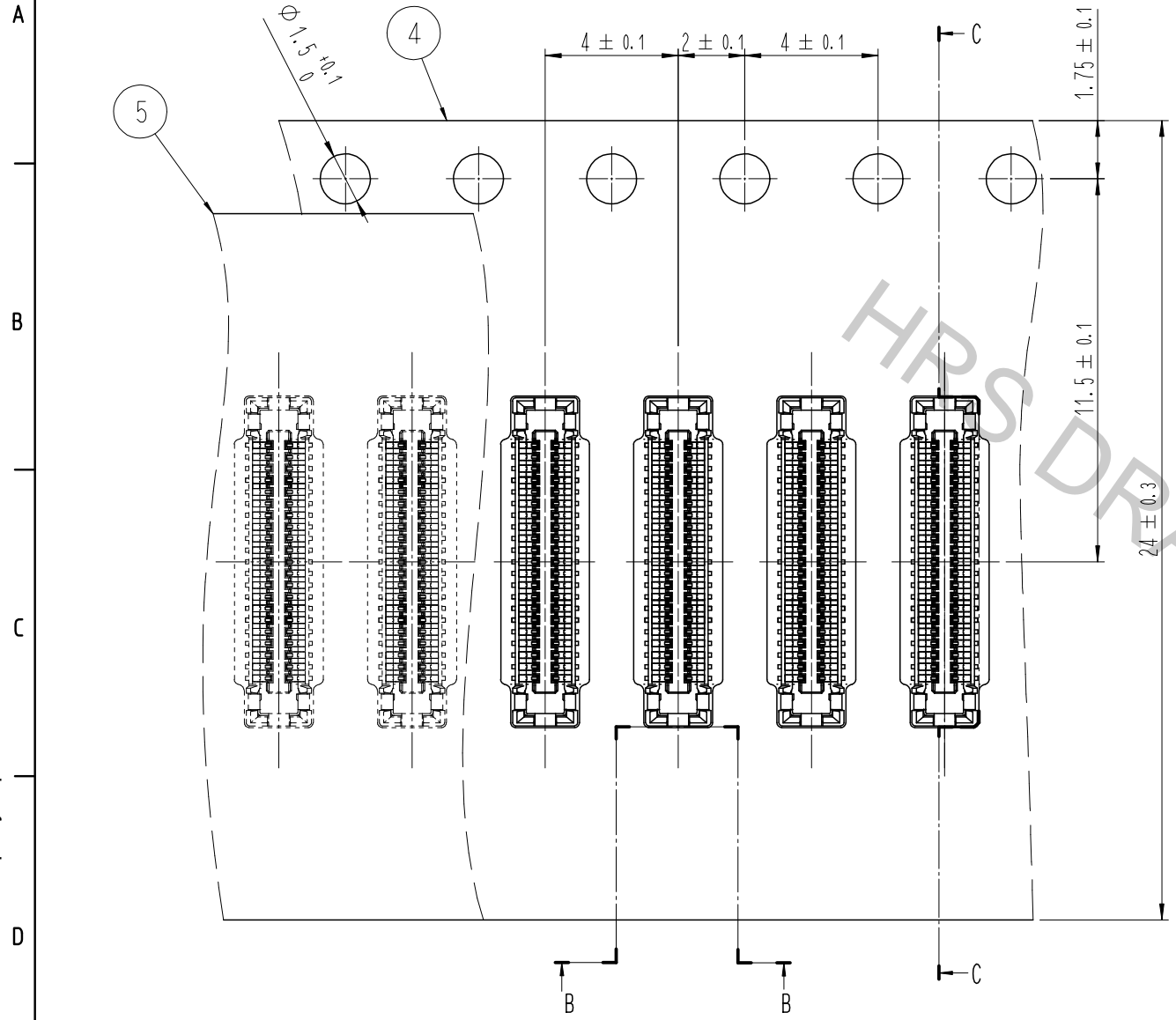

B-B (5:1)

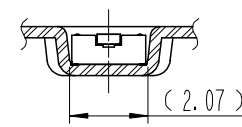

DIRECTION OF UNREELING

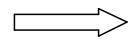

10 TAPING(FREE)

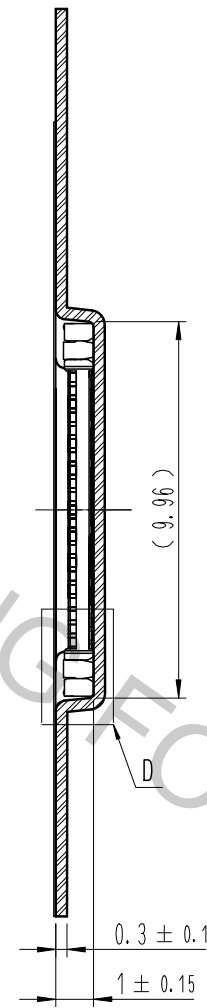
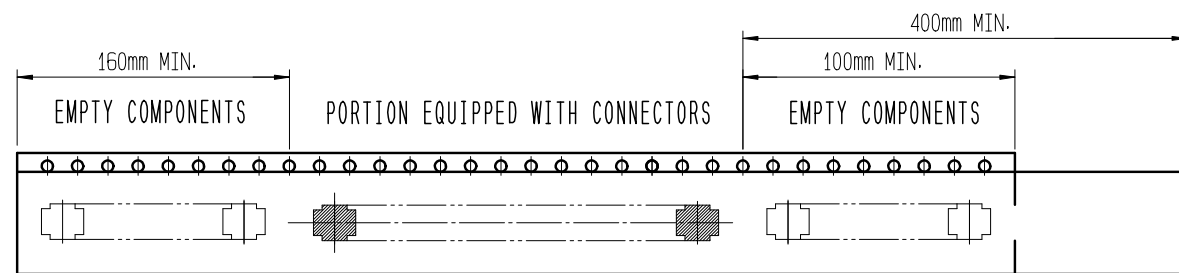

D (10:1)

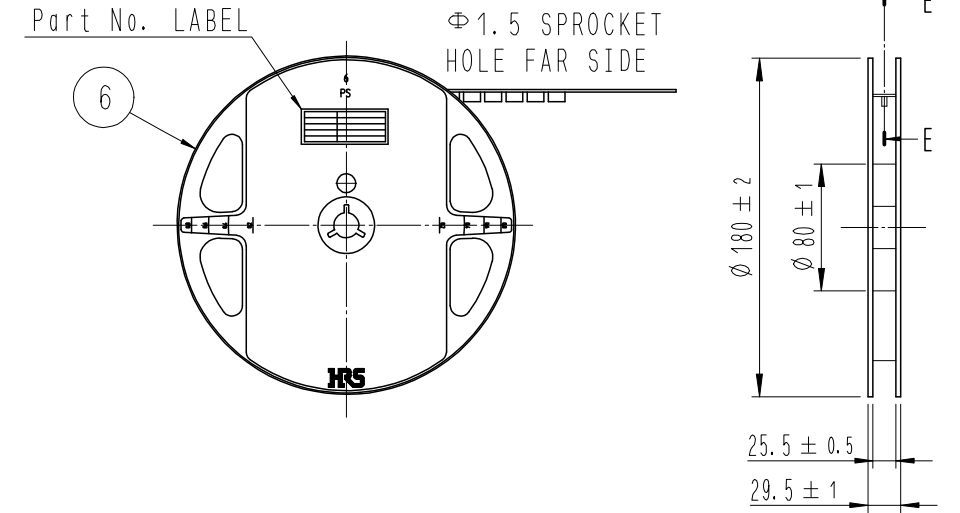
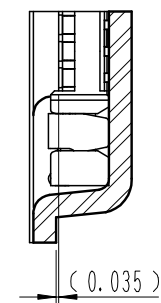

E-E (FREE)

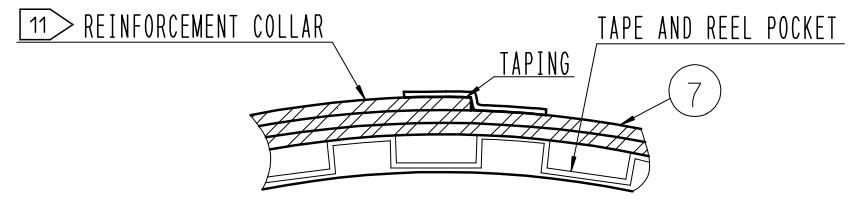

DETAIL OF PART No. LABEL

SUPPLIER	
QUANTITY	
PART NO.	
CODE NO.	
DATE OF MANUFACTURED	
生産月日	年 月 日
図番	** ** *
品名	BM23PF0.8-42DS-0.35V(895)
納入数量	1,000個
納入者	HIROSE KOREA

- 7 . PER REEL 1,000 CONNECTORS.
- 8 . THE DIMENSIONS IN PARENTHESES ARE FOR REFERENCE.
- 9 REFER TO JIS C 0806, IEC-60286-3 (PACKAGING OF COMPONENTS FOR AUTOMATIC HANDLING)
- 10 AFTER PACKAGING, ROLL 2 METERS OF THE REINFORCEMENT COLLAR TO OUTER CIRCUMFERENCE OF TAPE AND REEL POCKET, AND TAPE DOWN AT THE END THE COLLAR.

SCALE 10:1	DRAWING NO.	EDC3-632163	PART NO.	BM23PF0.8-42DS-0.35V(895)
	UNITS mm	HRS HIROSE KOREA CO., LTD.		CODE NO.