

CPDQR5V0H-HF

RoHS Device
Halogen Free

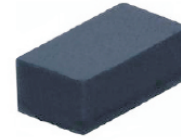

Features

- Bi-directional ESD protection
- IEC 61000-4-5 (surge) ; IPP=7A
- IEC 61000-4-2 (ESD) ; ±30KV(contact)
- Low clamping voltage
- Low leakage current

Mechanical data

- Case: 0402/SOD-923F Standard package ,
molded plastic.
- Terminals: Gold plated, solderable per
MIL-STD-750, method 2026.
- Marking Code: E5
- Mounting position: Any.
- Weight: 0.001 gram (approx.).

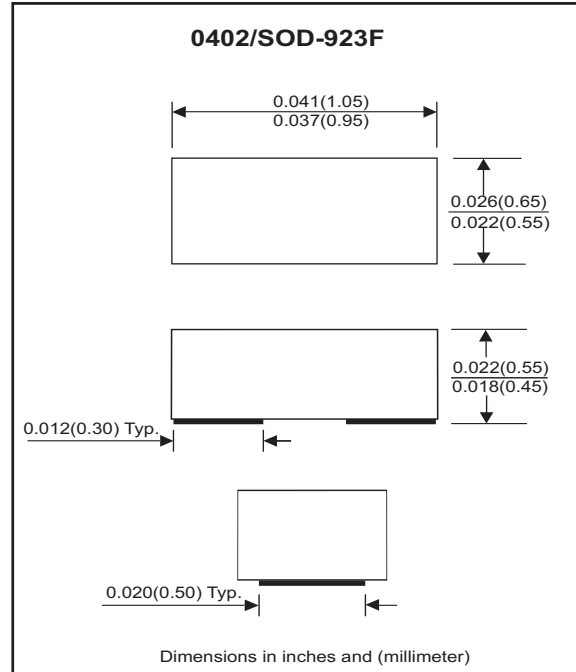

Maximum Rating and Electrical Characteristics (at TA=25 °C unless otherwise noted)

Parameter	Conditions	Symbol	Min	Typ	Max	Unit
Diode breakdown voltage	I _R = 1mA	V _{BD}	5.5	7.0		V
Leakage current	V _R = 5V	I _L			1.0	uA
Junction capacitance	V _R = 0V, f = 1MHz	C _T			20	pF
ESD capability	IEC 61000-4-2(air)	ESD			30	kV
	IEC 61000-4-2(contact)	ESD			30	kV
Clamping Voltage	I _{PP} = 1 A, t _p =8/20us	V _c			11	V
	I _{PP} = 7 A, t _p =8/20us	V _c			20	V
Peak Pulse Power	T _P =8/20us	P _{PP}			140	W
Operation temperature		T _j			125	°C
Storage temperature		T _{STG}	-55		150	°C

RATING AND CHARACTERISTIC CURVES (CPDQR5V0H-HF)

Fig. 1 - 8/20us Peak pulse current wave form acc. IEC 61000-4-5

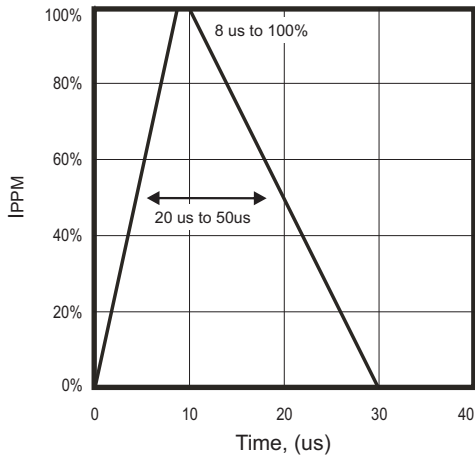

Fig. 2 - Capacitance between terminals characteristics

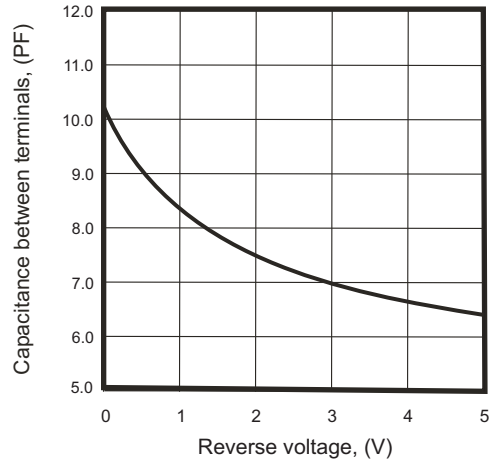

Fig.3 - Clamping voltage vs. peak pulse current

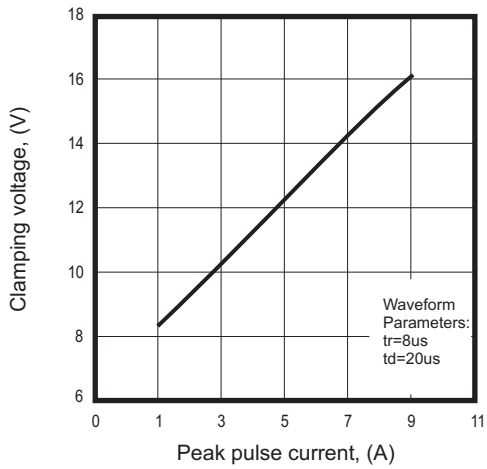
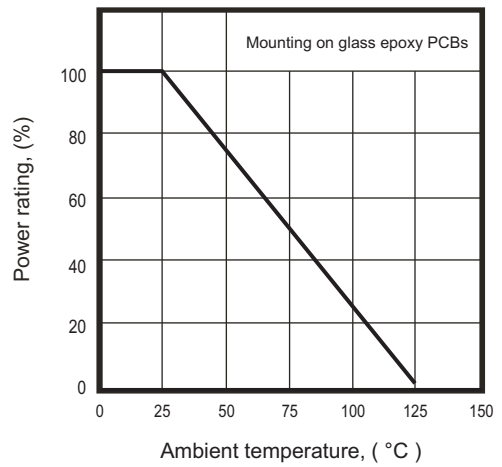
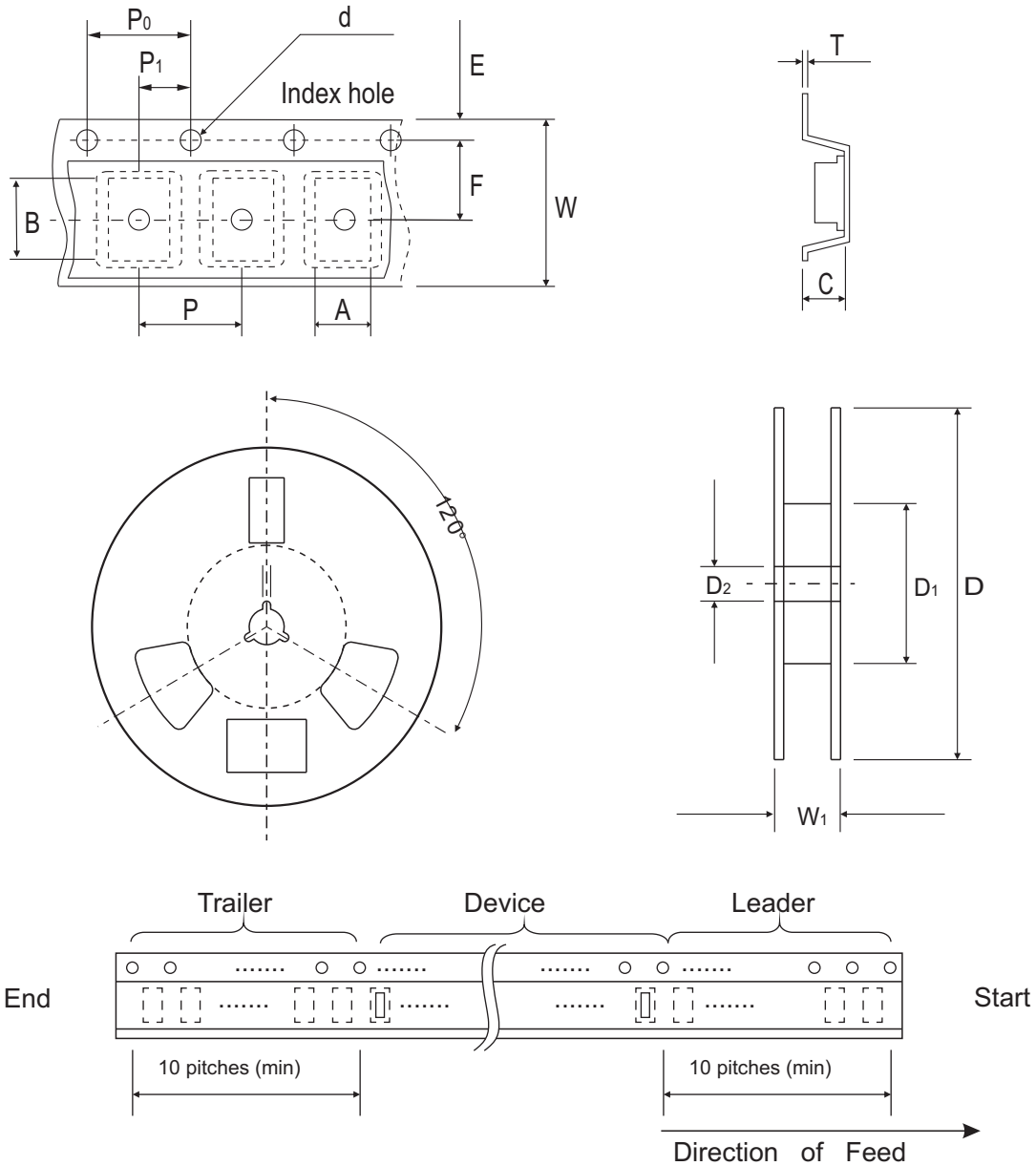

Fig. 4 - Power rating derating curve



Reel Taping Specification



0402 (SOD-923F)	SYMBOL	A	B	C	D	D1	D2	d
	(mm)	0.75 ± 0.05	1.17 ± 0.05	0.65 ± 0.05	178 ± 1	60.0 Min	13.0 ± 0.20	1.50 + 0.10/-0.00
	(inch)	0.030 ± 0.002	0.046 ± 0.002	0.026 ± 0.002	7.008 ± 0.04	2.362 Min	0.512 ± 0.008	0.060 + 0.004/-0.00

0402 (SOD-923F)	SYMBOL	E	F	P	P0	P1	W	W1	t
	(mm)	1.75 ± 0.10	3.50 ± 0.10	4.00 ± 0.10	4.00 ± 0.10	2.00 ± 0.10	8.00 ± 0.20	13.50 Max	0.20 + 0.02/-0.05
	(inch)	0.069 ± 0.004	0.138 ± 0.004	0.157 ± 0.004	0.157 ± 0.004	0.079 ± 0.004	0.315 ± 0.008	0.531 Max	0.008 + 0.001/-0.002

Marking Code

Part Number	Marking Code
CPDQR5V0H-HF	E5



Suggested PAD Layout

SIZE	0402/SOD-923F	
	(mm)	(inch)
A	0.750	0.030
B	0.500	0.020
C	0.700	0.028
D	1.250	0.049
E	0.250	0.010

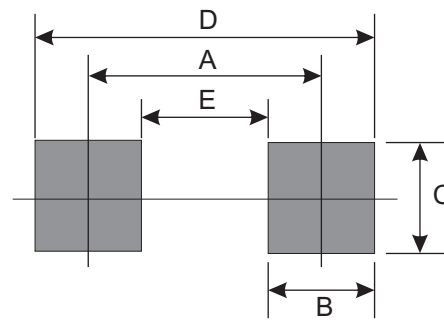

Standard Packaging

Case Type	Qty Per Reel	Reel Size
	(Pcs)	(inch)
0402/SOD-923F	5,000	7