

## Features

- High Gain: 24 dB
- P1dB: 37.5 dBm
- P<sub>SAT</sub>: 38.5 dBm
- IM3 Level: -24 dBc @ P<sub>OUT</sub> = 33 dBm/tone
- Power Added Efficiency: 23% @ P<sub>SAT</sub>
- Return Loss: 12 dB
- Bare Die Dimensions: 3.6 x 3.8 x 0.05 mm
- RoHS\* Compliant

## Description

The MAAP-011140-DIE is a 4-stage, 6 W power amplifier in bare die form. This power amplifier operates from 27.5 to 30.0 GHz and provides 24 dB of linear gain, 6 W saturated output power, and 23% efficiency while biased at 6 V.

The MAAP-011140-DIE is a power amplifier ideally suited for VSAT communications.

This product is fabricated using a GaAs pHEMT device process which features full passivation for enhanced reliability.

## Ordering Information

Part Number	Package
MAAP-011140-DIE	Die in Gel Pack <sup>1</sup>

1. Die quantity varies

## Functional Diagram

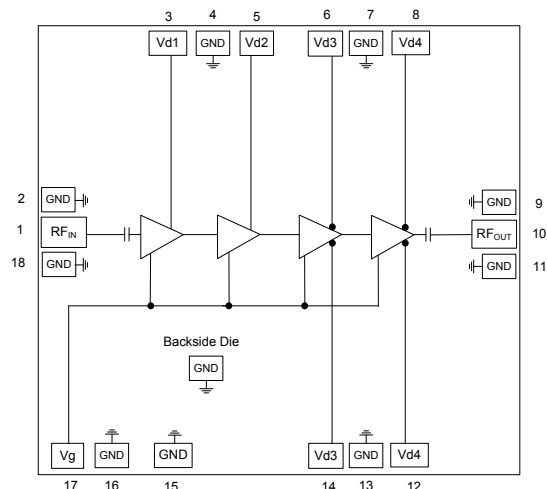

## Pin Configuration<sup>2</sup>

Pad	Function	Description
1	RF <sub>IN</sub>	RF Input
2, 4, 7, 9, 11, 13, 15, 16, 18 & backside	GND	Ground
3	V <sub>D1</sub>	Drain Voltage Stage 1
5	V <sub>D2</sub>	Drain Voltage Stage 2
6, 14	V <sub>D3</sub>	Drain Voltage Stage 3
8, 12	V <sub>D4</sub>	Drain Voltage Stage 4
10	RF <sub>OUT</sub>	RF Output
17	V <sub>G</sub>	Gate Voltage

2. Backside metal is RF, DC and thermal ground.

\* Restrictions on Hazardous Substances, European Union Directive 2011/65/EU.

**Electrical Specifications<sup>3</sup>: Freq. = 30 GHz, T<sub>C</sub> = +25°C, V<sub>D</sub> = +6 V, Z<sub>0</sub> = 50 Ω**

Parameter	Test Conditions	Units	Min.	Typ.	Max.
Gain	P <sub>IN</sub> = 0 dBm	dB	22	24	—
P <sub>OUT</sub>	P <sub>IN</sub> = 17 dBm	dBm	36.0	37.5	—
IM3 Level	P <sub>OUT</sub> = 33 dBm / tone	dBc	—	-24	—
Power Added Efficiency	P <sub>SAT</sub> (P <sub>IN</sub> = 17 dBm)	%		23	
Input Return Loss	P <sub>IN</sub> = -20 dBm	dB	—	12	—
Output Return Loss	P <sub>IN</sub> = -20 dBm	dB	—	12	—
Quiescent Current	I <sub>DQ</sub> (see bias conditions, page 5 )	mA	—	3000	—
Current	P <sub>SAT</sub> (P <sub>IN</sub> = 17 dBm)	mA	—	5250	—

3. Specifications apply to MMIC die with two RF input and two RF output bond wires, and tested with 50 Ω GSG probes. Further performance tuning to optimize the RF input and RF output impedance matching is shown on Recommended Bonding Diagram and PCB Layout Detail (pg. 4). Typical performance curves are achieved by using the recommended bonding diagram and PCB layout detail.

## Maximum Operating Ratings

Parameter	Rating
Input Power	+19 dBm
Junction Temperature <sup>4,5</sup>	+160°C
Operating Temperature	-40°C to +85°C

4. Operating at nominal conditions with T<sub>C</sub> ≤ +160°C will ensure MTTF > 1 x 10<sup>6</sup> hours.

5. Junction Temperature (T<sub>J</sub>) = T<sub>C</sub> + Θ<sub>JC</sub> \* ((V \* I) - (P<sub>out</sub> - P<sub>IN</sub>))

Typical thermal resistance (Θ<sub>JC</sub>) = 3.4°C/W.

a) For T<sub>C</sub> = +25°C,

T<sub>J</sub> = 108°C @ 6 V, 5.25 A, P<sub>OUT</sub> = 38.5, P<sub>IN</sub> = 17 dBm

b) For T<sub>C</sub> = +80°C,

T<sub>J</sub> = 159°C @ 6 V, 4.96 A, P<sub>OUT</sub> = 38.1, P<sub>IN</sub> = 17 dBm

## Absolute Maximum Ratings<sup>6,7</sup>

Parameter	Absolute Maximum
Input Power	+24 dBm
Drain Voltage	+6.5 V
Gate Voltage	-3 to 0 V
Junction Temperature <sup>8</sup>	+175°C
Storage Temperature	-65°C to +150°C

6. Exceeding any one or combination of these limits may cause permanent damage to this device.

7. MACOM does not recommend sustained operation near these survivability limits.

8. Junction Temperature directly effects device MTTF. Junction temperature should be kept as low as possible to maximize lifetime.

## Application PCB Layout

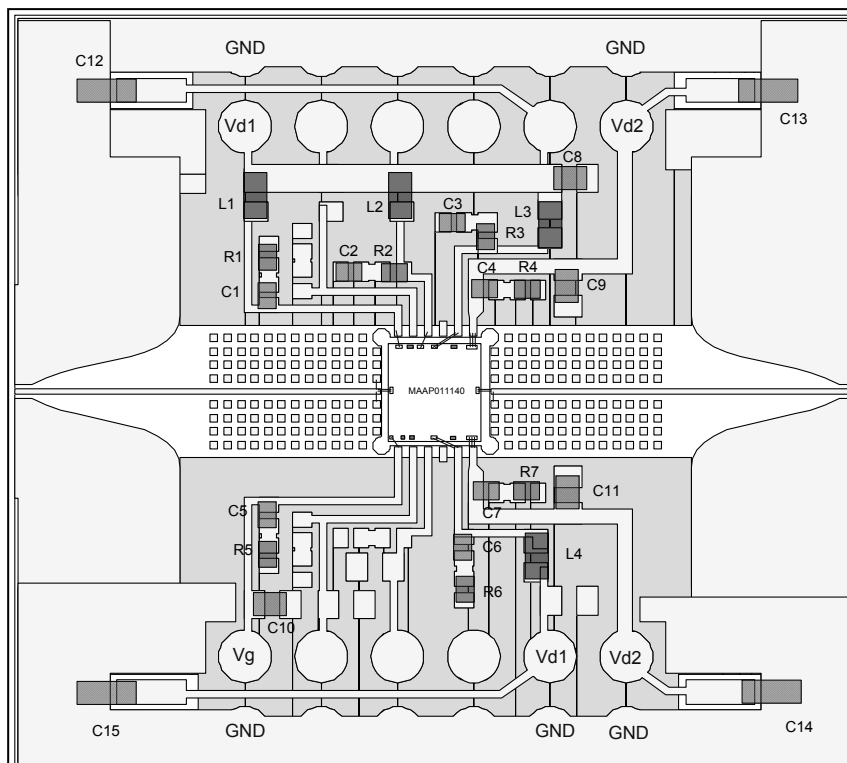

## Application Diagram

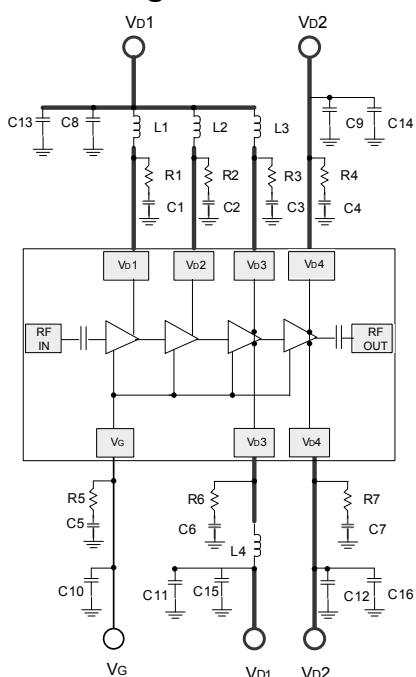

## Application Parts List

Part	Value	Case Style
C1 - C7	0.01 $\mu$ F	0402
C8 - C12	1 $\mu$ F	0603
C13 - C16	10 $\mu$ F	0805
R1 - R7	10 $\Omega$	0402
L1 - L4 (Chip Ferrite Bead)	BLM18HE601SN1D	0603

## PCB Material Specifications

Top Layer: 1/2 oz Copper Cladding, 0.017 mm thickness  
Dielectric Layer: Rogers RO4350B, 0.101 mm thickness  
Bottom Layer: 1/2 oz Copper Cladding, 0.017 mm thickness  
Finished overall thickness: 0.135 mm

## Recommended Bonding Diagram and PCB Layout Detail:

For optimum power match, RF input and output microstrip lines require open stubs on the application board for bonding wire inductance compensation. Optimum bonding wire inductance for the RF I/O connection is 0.2 nH, and physical length for the gold bond wire (.001" dia.) is approximately 350  $\mu\text{m}$  each for the two wire connection.

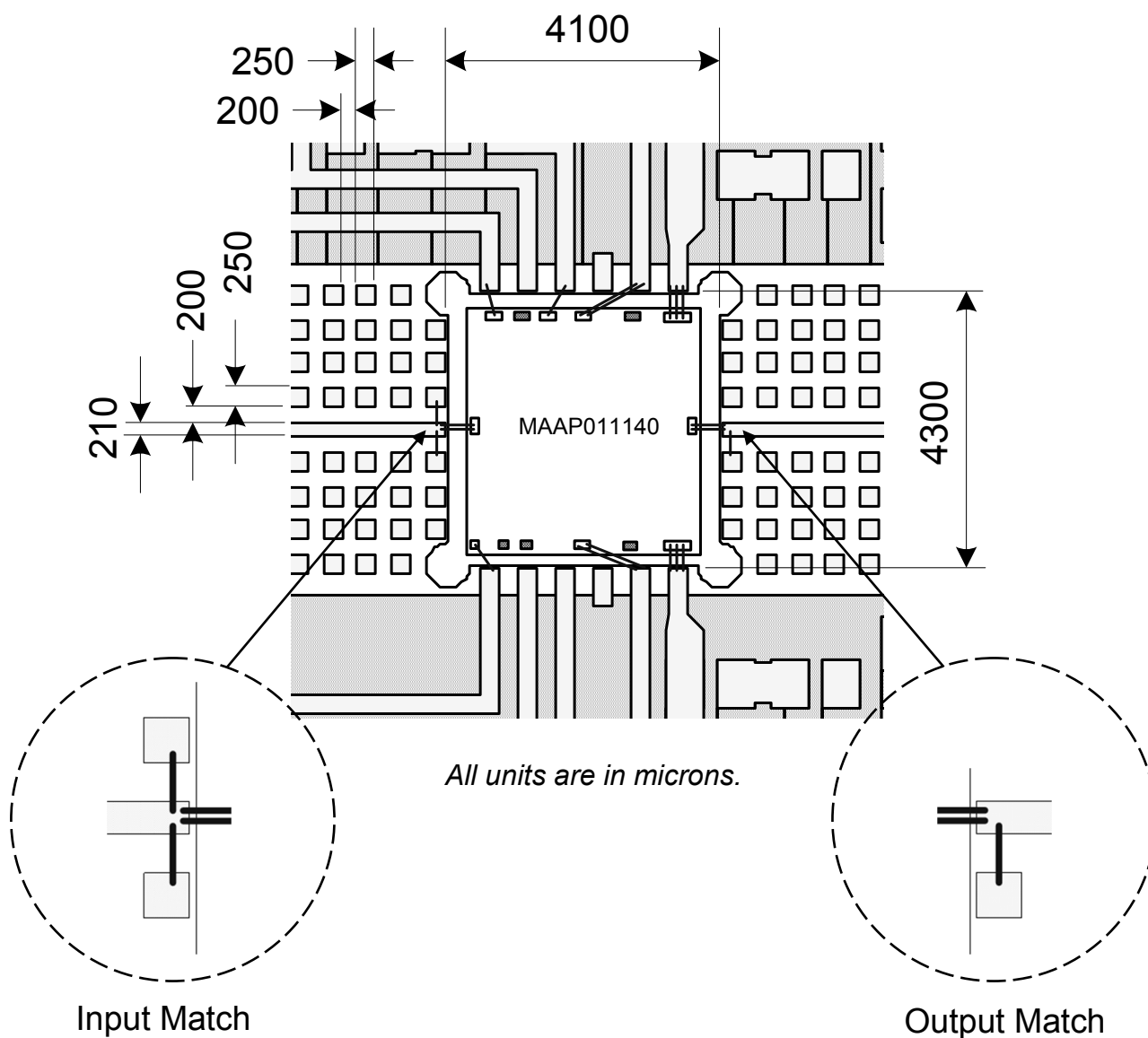

## Application Information

The MAAP-011140 is designed to be easy to use yet high performance. The ultra small size and simple bias allows easy placement on system board. RF input and output ports are DC de-coupled internally.

## Biasing conditions

Recommended biasing conditions are  $V_D = 6$  V,  $I_{DQ} = 3000$  mA (controlled with  $V_G$ ). The drain bias voltage range,  $V_D$ , is 3 to 6.5 V, and the quiescent drain current biasing range,  $I_{DQ}$ , is 2000 to 4000 mA.

$V_D$  bias must be applied to  $V_{D1}$ ,  $V_{D2}$ ,  $V_{D3}$ , and  $V_{D4}$  pads.

Both  $V_{D3}$  pads (6 and 14) are required for current symmetry.

Both  $V_{D4}$  pads (8 and 12), are required for current symmetry.

A single DC voltage ( $V_G$ ) will bias all amplifier stages. Muting can be accomplished by setting the  $V_G$  to the pinched off voltage ( $V_G = -2$  V).

## Die Attachment

This product is manufactured from 0.050 mm (0.002") thick GaAs substrate and has vias through to the backside to enable grounding to the circuit.

Recommended conductive epoxy is Namics Unimec XH9890-6. Epoxy should be applied and cured in accordance with the manufacturer's specifications and should avoid contact with the top of the die.

## Operating the MAAP-011140-DIE

### Turn-on

1. Apply  $V_G$  (-1.5 V).
2. Apply  $V_D$  (6.0 V typical).
3. Set  $I_{DQ}$  by adjusting  $V_G$  more positive (typically  $V_G \sim -0.9$  V for  $I_{DQ} = 3000$  mA).
4. Apply  $RF_{IN}$  signal.

### Turn-off

1. Remove  $RF_{IN}$  signal.
2. Decrease  $V_G$  to -1.5 V.
3. Decrease  $V_D$  to 0 V.

## Handling Procedures

Please observe the following precautions to avoid damage:

### Static Sensitivity

These electronic devices are sensitive to electrostatic discharge (ESD) and can be damaged by static electricity. Proper ESD control techniques should be used when handling these devices.

## Typical Performance Curves<sup>9</sup>

**Small Signal Gain vs. Frequency over Temperature**

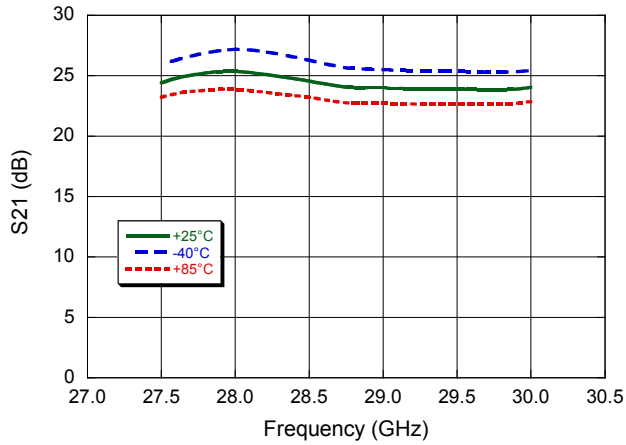

**Small Signal Gain vs. Frequency over Bias Voltage**

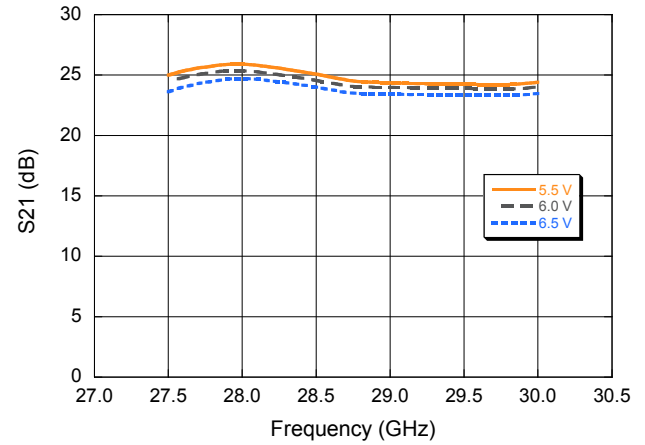

**Input Return Loss vs. Frequency over Temperature**

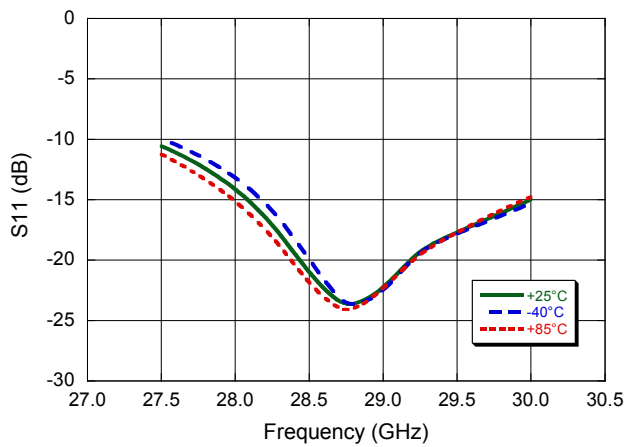

**Input Return Loss vs. Frequency over Bias Voltage**

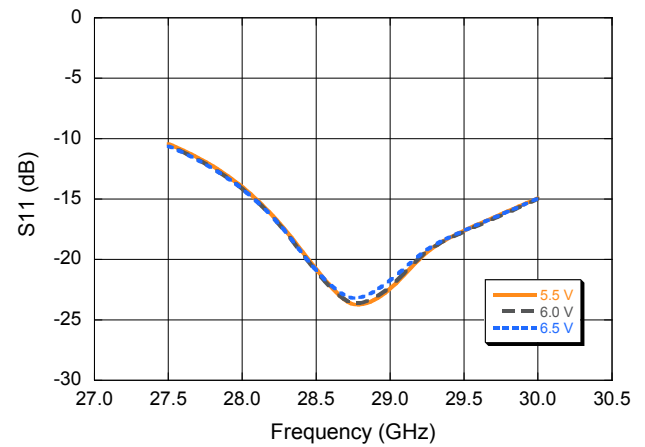

**Output Return Loss vs. Frequency over Temperature**

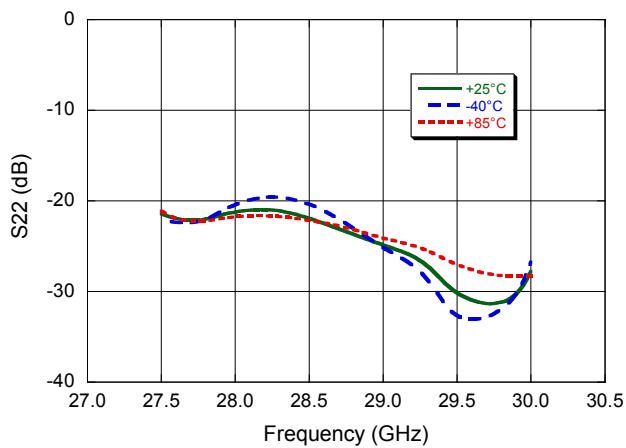

**Output Return Loss vs. Frequency over Bias Voltage**

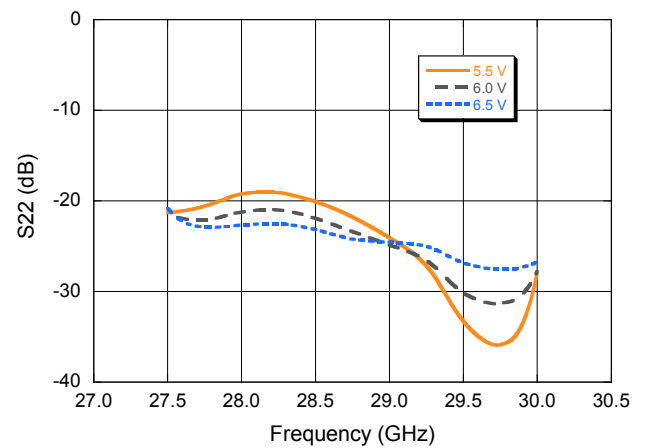

## Typical Performance Curves<sup>9</sup>

**$P_{SAT}$  vs. Frequency over Temperature**

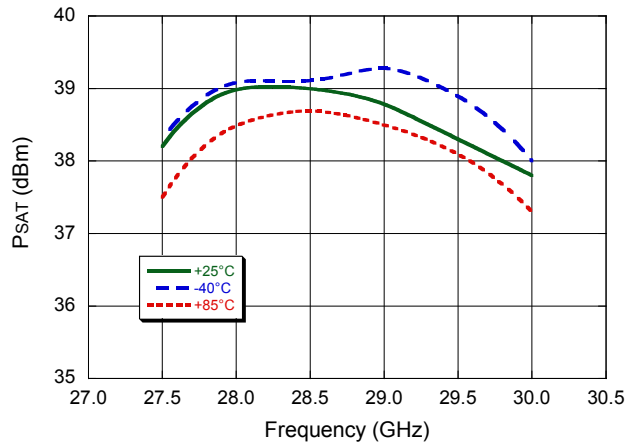

**$P_{SAT}$  vs. Frequency over Bias Voltage**

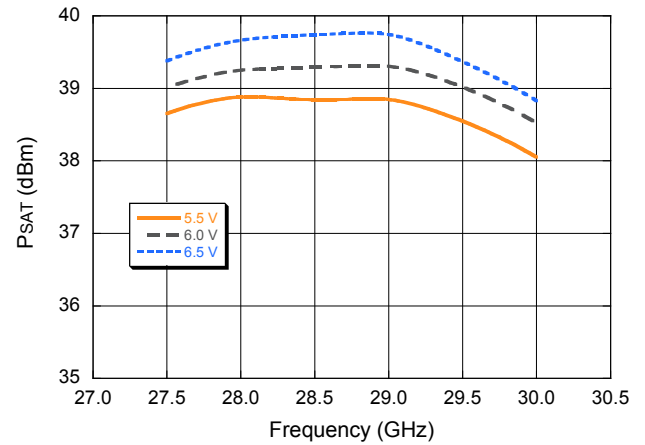

**$P_{1dB}$  vs. Frequency over Temperature**

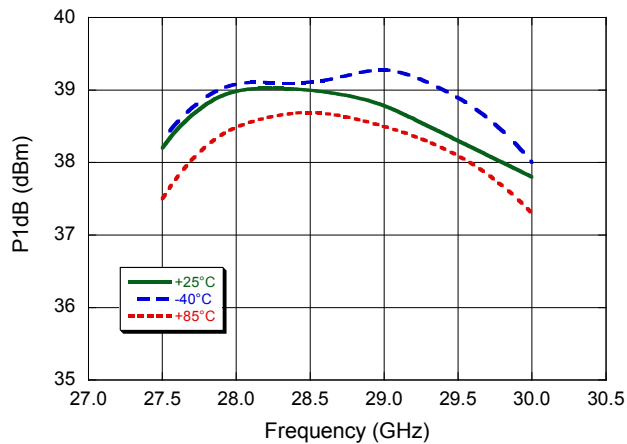

**$P_{1dB}$  vs. Frequency over Bias Voltage**

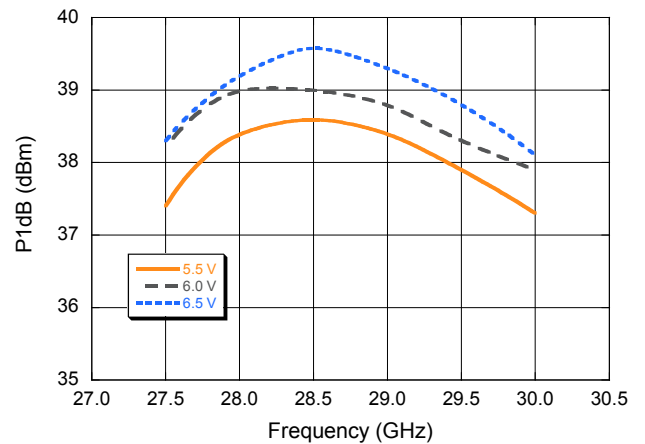

## Typical Performance Curves<sup>9</sup>

**Output IP3 vs. Frequency over Temperature**

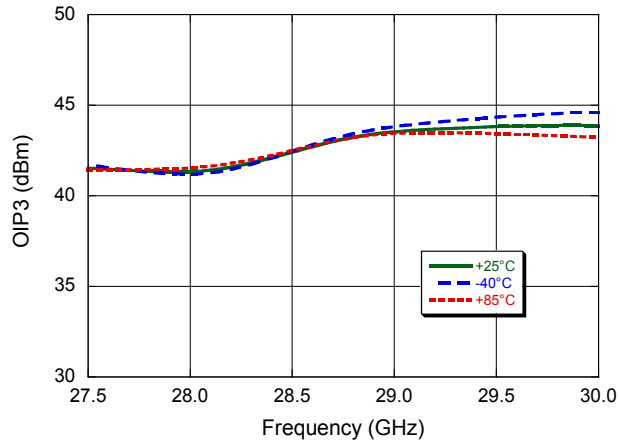

**Output IP3 vs. Frequency over Bias Voltage**

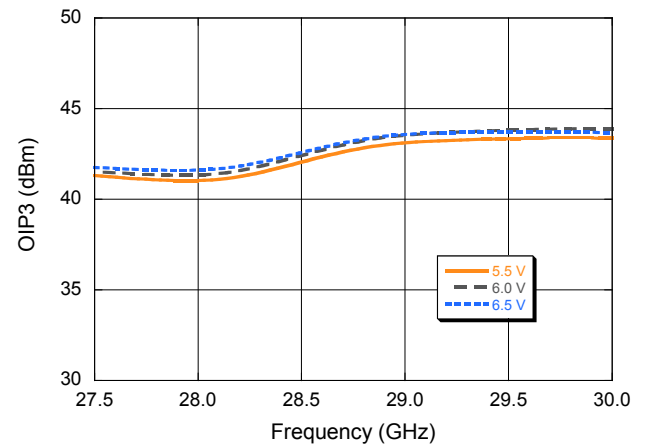

**IM3 vs. Frequency over Temperature**  
( $P_{OUT} = +33$  dBm/Tone)

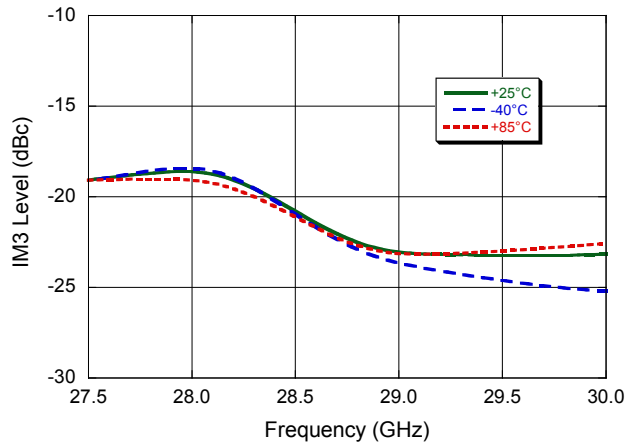

**IM3 vs. Frequency over Bias Voltage**  
( $P_{OUT} = +33$  dBm/Tone)

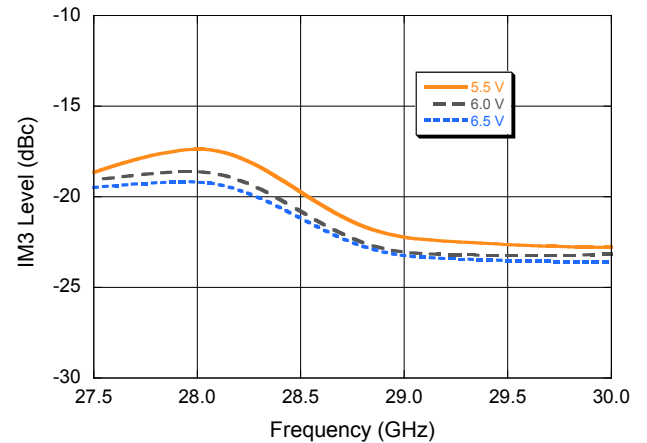



## Typical Performance Curves<sup>9</sup>

***P<sub>1dB</sub>, P<sub>SAT</sub> vs. Frequency***

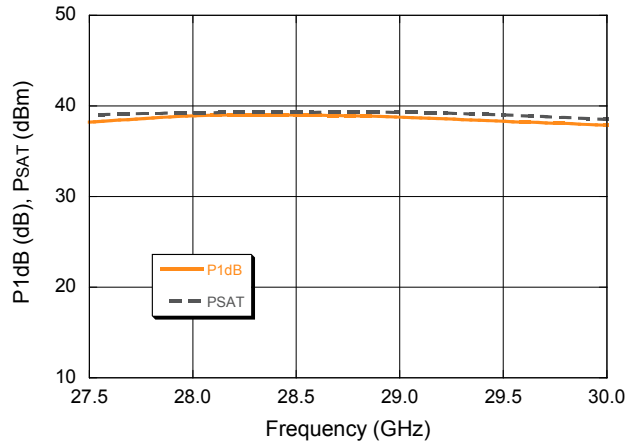

***PAE, Gain vs. Frequency***

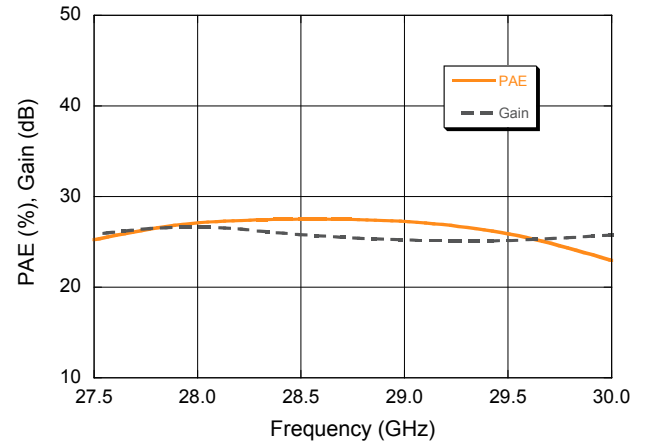

***IM3 vs. Output Power per Tone***

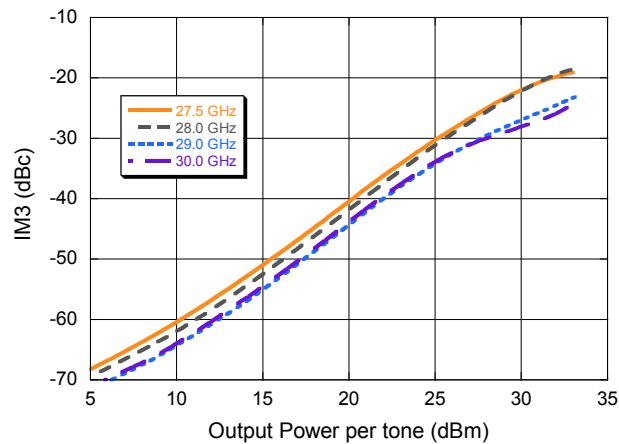

***Output IP3 vs. Output Power per Tone***

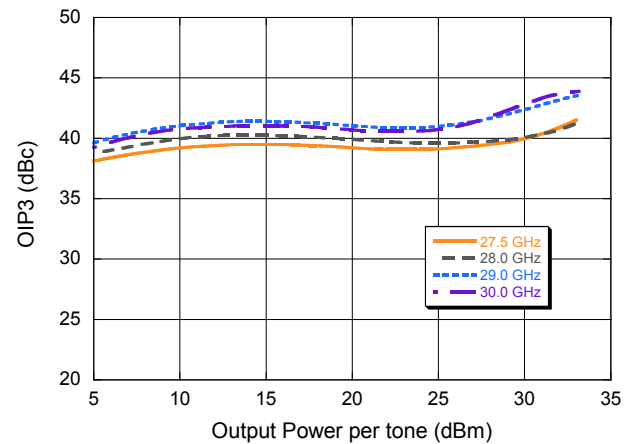

## Typical Performance Curves<sup>9</sup>

**Output Power vs. Input Power**

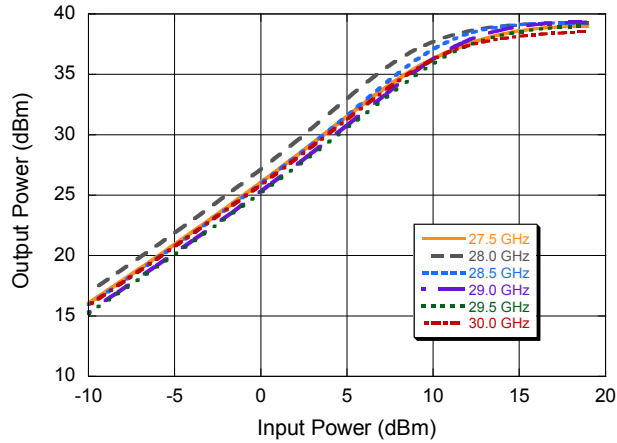

**PAE vs. Input Power**

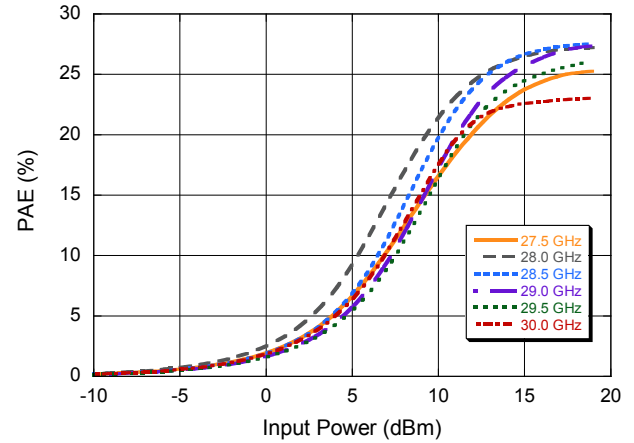

**Drain Current vs. Input Power**

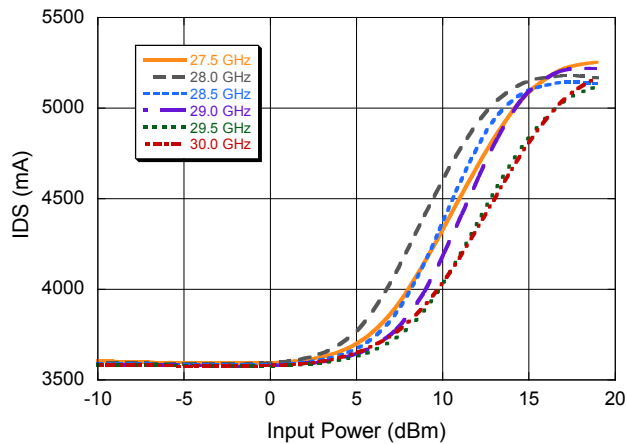

**Quiescent Drain Current over Temperature**

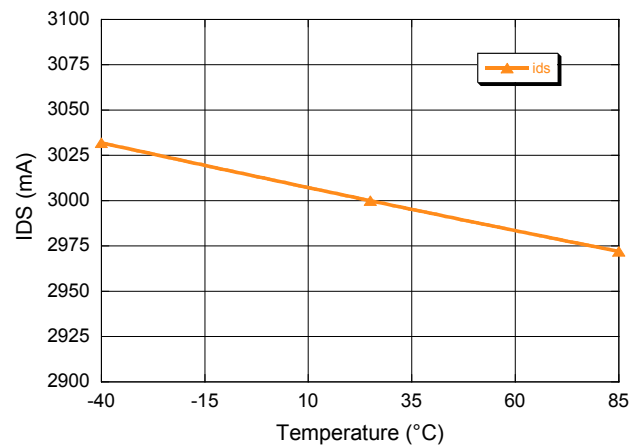

9. Typical performance curves are achieved by using the recommended bonding diagram and PCB layout detail.

## MMIC Die Outline

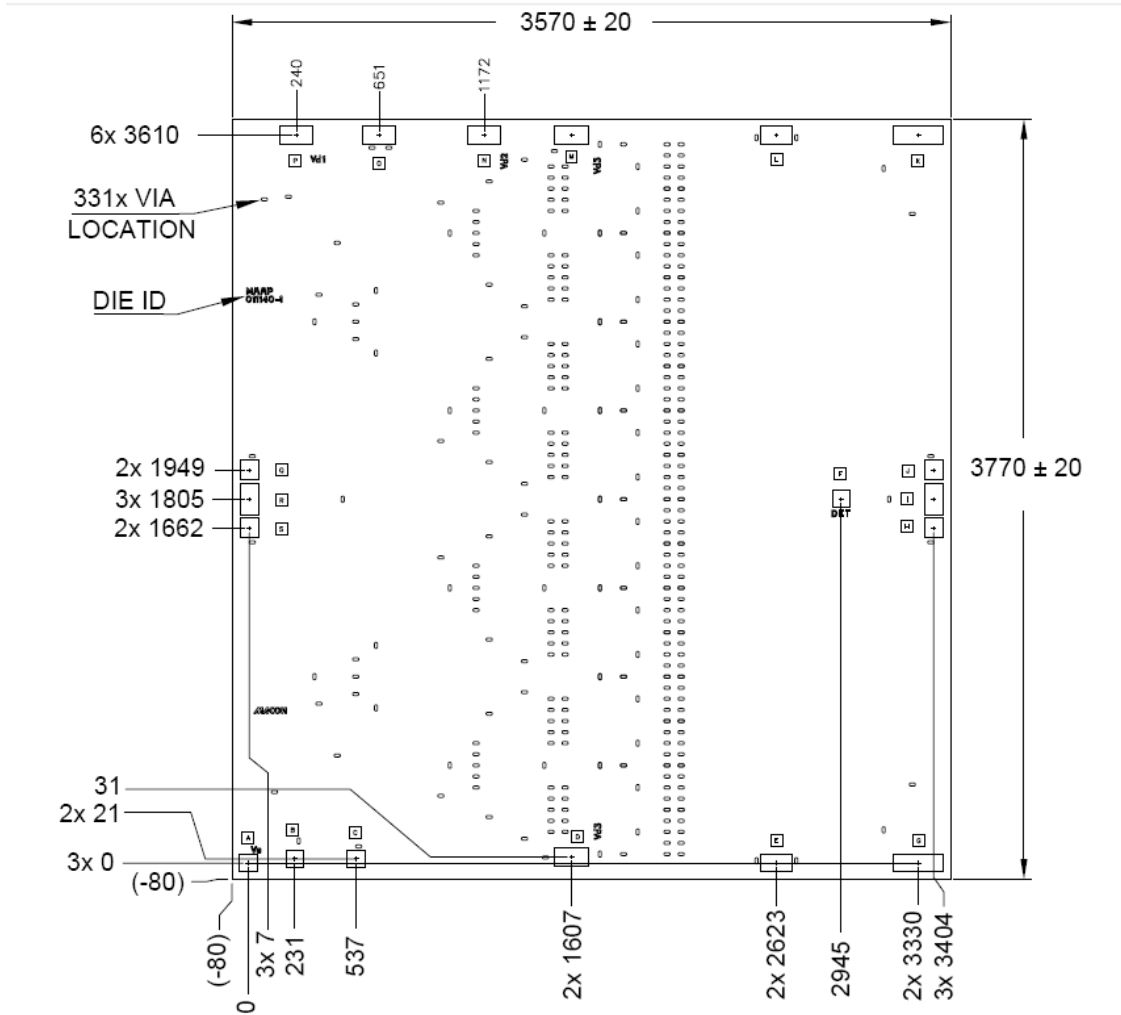

## Bond Pad Detail

Pad	Size (x)	Size (y)
A, B, C	88	88
D, M	169	88
E, L, O	161	88
F	84	84
G, K	249	88
H, J, Q, S	89	99
I, R	89	159
N, P	158	88

## Notes:

1. All units are in  $\mu\text{m}$ , unless otherwise noted, with a tolerance of  $\pm 5 \mu\text{m}$ .
2. Die thickness is  $50 \pm 10 \mu\text{m}$ .

M/A-COM Technology Solutions Inc. All rights reserved.

Information in this document is provided in connection with M/A-COM Technology Solutions Inc ("MACOM") products. These materials are provided by MACOM as a service to its customers and may be used for informational purposes only. Except as provided in MACOM's Terms and Conditions of Sale for such products or in any separate agreement related to this document, MACOM assumes no liability whatsoever. MACOM assumes no responsibility for errors or omissions in these materials. MACOM may make changes to specifications and product descriptions at any time, without notice. MACOM makes no commitment to update the information and shall have no responsibility whatsoever for conflicts or incompatibilities arising from future changes to its specifications and product descriptions. No license, express or implied, by estoppel or otherwise, to any intellectual property rights is granted by this document.

THESE MATERIALS ARE PROVIDED "AS IS" WITHOUT WARRANTY OF ANY KIND, EITHER EXPRESS OR IMPLIED, RELATING TO SALE AND/OR USE OF MACOM PRODUCTS INCLUDING LIABILITY OR WARRANTIES RELATING TO FITNESS FOR A PARTICULAR PURPOSE, CONSEQUENTIAL OR INCIDENTAL DAMAGES, MERCHANTABILITY, OR INFRINGEMENT OF ANY PATENT, COPYRIGHT OR OTHER INTELLECTUAL PROPERTY RIGHT. MACOM FURTHER DOES NOT WARRANT THE ACCURACY OR COMPLETENESS OF THE INFORMATION, TEXT, GRAPHICS OR OTHER ITEMS CONTAINED WITHIN THESE MATERIALS. MACOM SHALL NOT BE LIABLE FOR ANY SPECIAL, INDIRECT, INCIDENTAL, OR CONSEQUENTIAL DAMAGES, INCLUDING WITHOUT LIMITATION, LOST REVENUES OR LOST PROFITS, WHICH MAY RESULT FROM THE USE OF THESE MATERIALS.

MACOM products are not intended for use in medical, lifesaving or life sustaining applications. MACOM customers using or selling MACOM products for use in such applications do so at their own risk and agree to fully indemnify MACOM for any damages resulting from such improper use or sale.